

WATERPROOF HANDS FREE SPORTS CAMERA

# **USER    MANUAL**

SUPPORTING 4G SD CARD

## **I) Quick Start**

### **Turning the Camera On**

Press and hold the On/Off Button for 2 seconds (two beeping sounds). The LCD screen will show the remaining time.

### **Taking Video Footage**

1. Aim at what you want to record.
2. Press and hold the 'Movie shutter button' for 2 seconds to start recording (one beeping sound). The time elapsed will be shown on the LCD screen.
3. Press and hold the 'Movie shutter button' again for 2 seconds to stop recording (two beeping sounds). The length of the video footage will show on the LCD screen for 2 seconds, after which the remaining time will be shown (the remaining time is an estimate only).

## **II) Camera Precautions**

### **Notice the following guidelines when using your camera**

- The CAM is shock resistant, not shock proof.
- For your safety, do not press the buttons on the camera during sports activities.
- Do not place the camera in areas prone to dust or damp for extended periods of time. This may cause a fire or an electrical shock.
- Do not leave the camera in places exposed to extremely high temperatures, such as under direct sunlight, for extended periods of time. This may affect the camera housing and internal components.
- Clean the lens with a soft cloth to remove fingerprints or dust.
- We recommend using Alkaline batteries in temperatures between 32°F to 104°F (0°C to 40°C).
- The working temperature range of a normal Alkaline AA battery is 32°F to 104°F (0°C to 40°C). Above or below this temperature may cause the batteries to malfunction, therefore for use in low temperature, we recommend changing to Lithium batteries.
- Turn the camera off before removing the batteries or memory card. The card and the data may be damaged if the memory card is inserted or removed while the camera is still on.
- Remove the batteries and memory card before storing the camera for long periods of time. Keep it in a well-ventilated place to prevent mould.
- Under the following circumstances, have the camera repaired by qualified personnel:
  - a) The plug is damaged or worn.
  - b) The device has been dropped and/or the housing has been damaged.
  - c) Liquid has entered the camera.

**Notes on copyright:** Users are asked to note that the transfer of memory containing photos or data protected under copyright laws is only permissible within the restrictions imposed. Users assume all responsibility in the event that copyrights are violated by the use of this camera.

### **Waterproof Feature**

The CAM camera is waterproof up to 3m (10ft). We will not assume any responsibility for camera malfunction caused by liquid entering the camera as a result of misuse by the user.

### **Precaution:**

Follow the steps below to keep the camera waterproof.

Step 1: Apply silicon grease (included).

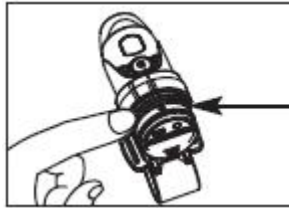

Take out the o-rings and use your fingers to gently rub on a thin layer of silicon grease onto the surface of the o-rings. The silicon grease needs to be applied on the o-rings evenly.

Step 2: Ensure both o-rings are attached.



Both o-rings need silicon grease applied to them. Follow the instructions in Step 1.

Step 3: Replace the cover.



Make sure the cover is firmly closed.

**Liquid may get inside the camera if the battery cover is not firmly closed**

- If the camera gets wet, wipe the liquid off as soon as possible with a dry cloth.
- Other camera accessories may not be waterproof.
- Ensure the o-rings are clean and have silicon grease applied before use underwater or in wet conditions.

**Using the camera in cold weather**

- We recommend using Energizer e2 lithium batteries in cold weather.

**Don't use the camera in extreme temperatures as this may cause the camera to malfunction.**

**Attention:**

- Non-rechargeable batteries are not to be recharged;
- Rechargeable batteries are to be removed from the camera before being charged;
- Rechargeable batteries are only to be charged under adult supervision;
- The supply terminals are not to be short-circuited;
- Exhausted batteries are to be removed from the camera.

**III) Technical Specifications**

- Sensor resolution 640x480 VGA CMOS sensor
- Built-in memory 32MB
- SD memory card drive supports cards of up to 4GB (not included)
- Movie storage:  
640 x 480 pixels (30\* frames per second)  
320 x 240 pixels (30\* frames per second)
- Status LCD 2-digit B/W
- Focusing range 3m~infinity

- Movie images AVI
- File format of Interface USB (1.1)
- Delete image All / last one
- Auto Shut-Off 30 minutes
- Battery 2 x 1.5V AA alkaline batteries (included)
- Dimensions 40mm diam. x 110mm length
- Operation system Win 2000/XP/Vista and Apple Mac X 10.4 and below

#### **IV) Computer System Requirements**

##### **Minimum System Requirements**

- Pentium III 800 MHz or higher
- Windows 2000, Windows XP, Windows Vista and Apple Mac X 10.4 and below
- 128 MB RAM
- 800 MB Free hard disk space
- SVGA 800 x 600 resolution video support (32 bit)
- 16 bit Windows compatible sound device

\* In some cases, the frame rate may be automatically reduced to maximize the memory usage.

#### **V) Camera Description**

1. Lens
2. Camera grip
3. Screw
4. Nut
5. Handlebar grip
6. Helmet grip
7. O-ring
8. USB cable
9. AV cable
10. Rubberized patch
11. Velcro patch
12. Short velcro strap
13. Long velcro strap
14. Silicon rubber  
head strap
15. Bolt
16. Mount lock and  
tripod mount
17. Silicon grease container
18. Webcam stand
19. Webcam installation CD
20. LCD screen
21. ON/OFF
22. Movie shutter button &  
Confirm button
23. Menu button & Select button
24. Mini-USB port

- 25. AV port
- 26. SD card slot
- 27. SD card (not included)
- 28. Battery door
- 29. Batteries (included)

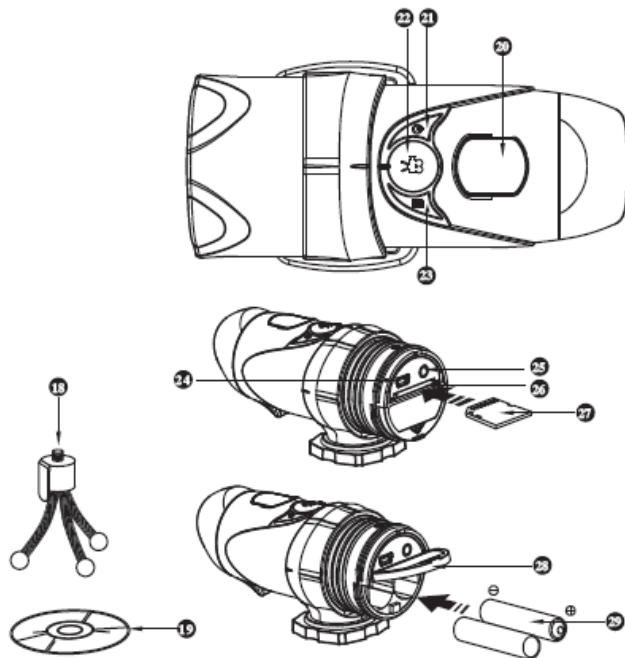
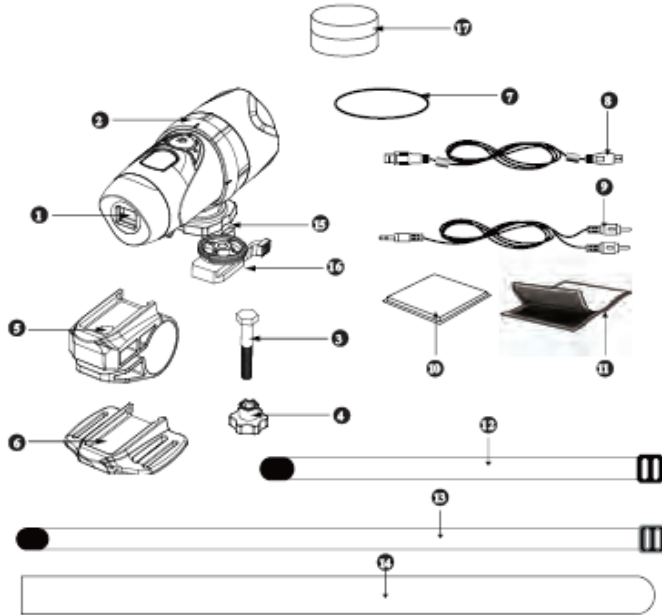

**VI) Camera Mounting Description**

The camera can be mounted in a number of ways using the straps and the velcro patch provided. Please follow the methods of mounting as suggested below:

**Fixing the position of the camera**

- a) With the base of the camera facing you, turn the clip clockwise to tighten its position.
- b) With the base of the camera facing you, turn the clip counter clockwise to loosen its position.



Note: Use caution when twisting; the clip may be sharp.

**Mounting the camera onto a helmet using the silicon rubber strap:**

1. Attach the rubberized patch to the bottom of the helmet mount grip.
- 2.+3. Thread the silicon rubber strap through the helmet grip.
4. Mount the helmet grip to the helmet using the silicon rubber strap.
5. Slide the camera into the helmet mount grip.
6. Adjust the angle of the camera making sure it's secure.
7. To avoid damage to the camera, the mount lock at the base must be loosened before twisting the camera.

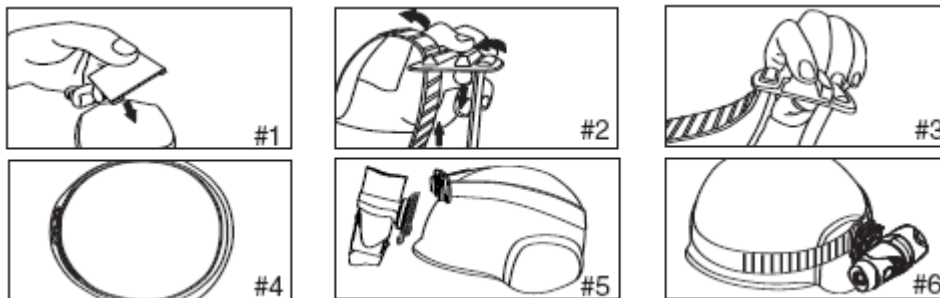

**Mounting the camera using the velcro strap:**

1. Attach the rubber patch to the bottom of the helmet grip.
- 2+3. Place the helmet grip on the helmet, and thread the velcro strap through the helmet grip.
4. Secure the velcro strap by fastening it through the helmet vents.
5. Slide the camera into the helmet mount grip, and adjust the angle of the camera making sure it is secure.

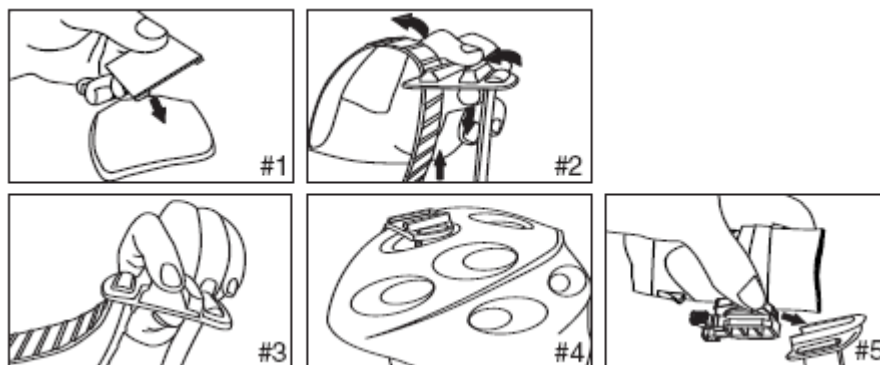

**Mounting the camera using the handlebar grip:**

1. Place the handlebar grip on the handlebar.

2. Add the screw and nut to hold the handlebar grip securely.
3. Slide the camera into the handlebar grip and make sure the handlebar grip is locked with the camera.
4. Adjust the angle of the camera.

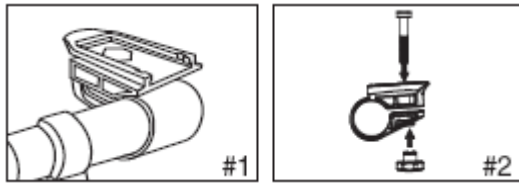

**Mounting the camera on a tripod or camera mount:**

1. Attach the tripod mount to the bottom of the camera.
2. With the tripod mount on the camera, screw it onto the webcam stand.
3. Adjust the angle of the camera.

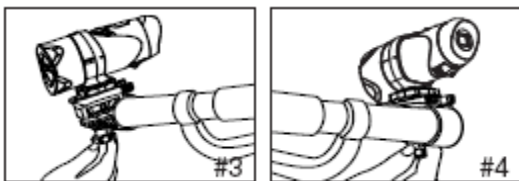

**VII) Camera Usage**

**Battery Installation**

**Use Caution, the edge of the base clip may be sharp.**

When unscrewing the cover make sure the clip is in the same direction as the lens. Observe the following precautions when unscrewing the cover of the camera:

1. Unscrew the cover at the end of the unit.
2. Place your finger on the 'lip', which is on the bottom half of the rear of the unit, and pull in an upward direction to open the battery slot door.
3. Insert 2 x AA alkaline batteries into the battery slot with the polarity in the direction as shown.
4. Close the battery slot door and screw on the end of unit cover.

**Note:** When the battery is low, the low battery icon will appear on the LCD screen.

**Always upload video footage to your PC prior to replacing batteries to avoid memory loss.**

**Note:**

- a) Do not mix old and new batteries together. Replace both batteries at the same time.
- b) Remove the batteries if the camera is not going to be used for extended periods of time.
- c) Do not mix alkaline, standard (carbon-zinc) or rechargeable (nickel-cadmium) batteries. Only batteries of the same or equivalent type as recommended are to be used together.

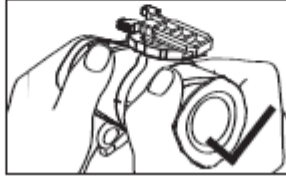
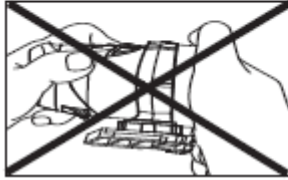
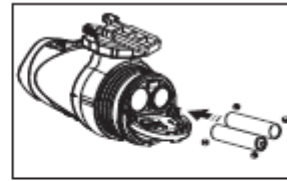
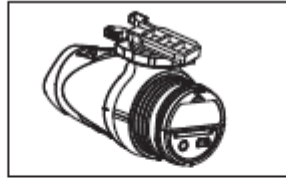
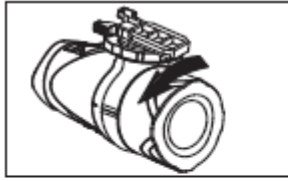

### Turning the Camera On

Press and hold the On/Off Button for 2 seconds (two beeping sounds). The LCD screen will show the remaining time.

For your safety, do not press any buttons on the camera during sports activities.

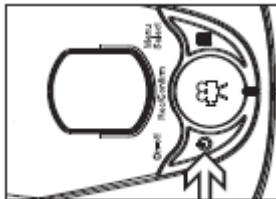

### Turning the Camera Off

1. Press and hold the On/Off Button for 2 seconds (two beeping sounds). The LCD screen will turn off.
2. The camera will be turned off automatically after 30 minutes of not being used unless it is in USB mode.

**Note:** If the camera is connected to your PC, you have to unplug the USB cable to turn the camera off.

**Note:** Ensure that the CAM is turned off during the insertion or the removal of the SD card. The card and the data may be damaged if the SD card is inserted or removed while the camera is on.

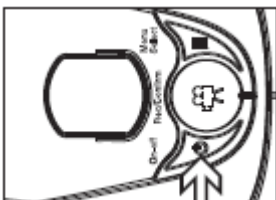

### SD card insertion/removal

#### Insert:

1. Turn the CAM off .
2. Unscrew the cover at the end of the unit.
3. Turn the SD card upside down (connect terminals facing up) then insert it carefully and completely until it clicks in place.
4. Screw the cover back onto the end of the unit.



### Remove:





1. Turn the CAM off .
2. Unscrew the cover at the end of the unit.
3. Push the card until it clicks, then pull the card out.
4. Screw the cover back onto the end of the unit.



### Note:

- a. Ensure the card is inserted correctly.
- b. Do not touch the connect terminals on the back of the SD card.
- c. The connect terminals should be facing the same way as the LCD screen.
- d. The card may be damaged if it is not fully inserted.
- e. The card and the data may be damaged if the SD card is inserted or removed while the camera is on.

### Taking Video Footage

1. Aim at what you want to record.
2. Press and hold the 'Movie shutter button'  for 2 seconds to start recording (one beeping sound). The time elapsed will be shown on the LCD screen.
3. Press and hold the 'Movie shutter button'  again for 2 seconds to stop recording (two beeping sounds). The length of the video footage will show on the LCD screen for 2 seconds, after which the remaining time will be shown (the remaining time is an estimate only).
4. Press the Menu button  to select the desired resolution (640 x 480, 320 x 240). Press the Menu button  again to shift through the icons representing these resolutions (at the top of the LCD screen). The icons will flash until you press Confirm  to verify your selection.

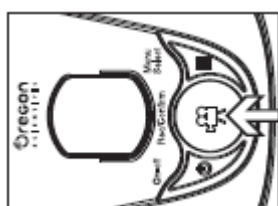



### Note:

1. Default resolution is 640 x 480 (VGA).
2. When the time is shown, you will see 'H' for hour, 'M' for minute, and 'S' for second.
3. If the recording time is long, the video file may be separated into two files automatically. The user does not need to monitor this process, the camera will resume filming once the file is saved (after a couple of seconds). Please note that the time duration needed to save video files may vary depending upon the length of the file. Please be patient during this process.

### VIII) Menu Settings

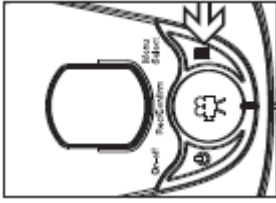
1. Press and hold the Menu button  for 2 seconds (one beeping sound) to start selecting options.









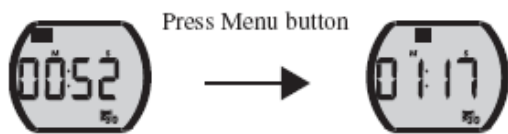



2. You can shift through different shooting modes by pressing the Menu button  repeatedly. The LCD will show each mode as you press the Menu button .

3. Press the 'Confirm' button  to confirm the selection (one beeping sound).

4. When you want to exit the Menu Selection mode, shift through the icons by pressing the Menu button repeatedly until the selected icon stops flashing. Alternatively you can hold Menu  down for 2 seconds. This will exit menu mode.







5. The different mode icons are shown in the table below.

Icon	Title	Description
	High resolution (640*480 pixels)	Large video format/ less storage capability
	Medium resolution (320*240 pixels)	Medium video format
	Low resolution (160*120 pixels)	Smallest video format/ more storage capability
	Sound	Sound recording
	Delete the last video footage	Erases the last video footage taken
	Delete all video footage	Erases all video footage stored
	Date and time	Sets the date and time
	30 frames per second	The frame rate of video footage is 30 frames per second (smooth and less storage capability)
	15 frames per second	The frame rate of video footage is 15 frames per second (less smooth and more storage capability)
	Low battery	Battery is low
	SD card	SD card is inserted in the camera



**640 x 480, 320 x 240 pixels resolution**

To change the resolution, press the Menu button  until the desired resolution icon is displayed on the LCD

screen. Press the 'Confirm' button  to confirm your selection. This camera allows you to choose from two video resolutions:  640 x 480 and  320 x 240. High resolution video footage has better quality because it has more pixels. Lower resolution has fewer pixels but enables the user to record for a longer period of time. The duration of video footage your camera can take depends on the resolution you choose. To switch between high resolution and medium resolution, press the Menu button  until the LCD screen shows the correct icon. Press the 'Confirm' button  to confirm your selection.



### Privacy Mode

This mode allows the user to disable the sound features.



The privacy icon will be flashing and the current mode it is in will not be shown. Press 'Menu'  to go onto the next menu mode – Sound Recording. Or, press 'Confirm'  to enter the privacy mode.

Once inside the Privacy Mode **P**, the icon **P** will continue to flash and ON will be displayed. If you select Confirm  this will disable the sound but still record the audio. If you select OFF, this will turn the Privacy Mode **P** OFF and enable the sound features while still recording the audio.



When in privacy mode option, pressing 'Menu' will change between ON and OFF. This will be looping. You must confirm one of the choices to move onto the next menu mode.

	Item	Picture size	fps
VGA		640 X 480 pixel	30
QVGA		320 X 240 pixel	30

### Sound Recording

Once you have entered this mode the icon will keep flashing and "LO" will be shown on screen. "LO" means sound is being recorded during filming. Press Menu  (one beeping sound) to switch to "OFF", which means no sound will be recorded. After "OFF", it will loop back to "HI" when 'Menu'  is pressed again. Press the 'Confirm' button  (one beeping sound) to confirm the setting and to go to the next function icon.



### Deleting video footage

To delete the last video footage that was recorded, press the Menu button  until the LCD screen shows .

Press the Confirm button  to confirm. Repeat these two steps to individually delete your files.

**Note:** After file deletion, the LCD screen will adjust the remaining number of files accordingly.



### Delete All Video Footage

To delete all video footage stored in your camera, press the Menu button  until the LCD screen shows .



Press the Confirm button  to verify.





**Note:** It may take a few minutes to delete multiple files at one time.

### Setting Date/Time (Clock Set)



Shift to the Date icon in the Menu mode by pressing the Menu button  repeatedly. When the Date icon is flashing, press the 'Confirm' button  to change the date and time.

#### Setting the Year

1. Press the 'Menu button'  to adjust the last digit of the year (2000-2009). Press the 'Confirm' button  to verify the last digit.



2. Press the 'Menu button'  to adjust the 3rd digit of the year (200X-209X). Pressing 'Confirm'  will then move the cursor to allow you to adjust the 3rd digit of the year. Press the 'Menu' button  to select the number and the 'Confirm' button  to verify, after which you will be able to adjust the month. 

#### Setting the Month



When adjusting the month, the “M” will be shown. Press the 'Menu button'  to adjust the month. Press the 'Confirm' button  to verify, after which you would be able to adjust the day and proceed to setting the day.





#### Setting the Day

When adjusting the day, the “D” will be shown. Press the 'Menu button'  to adjust the day. Press the 'Confirm' button  to verify, after which you would be able to adjust the and proceed to setting the time. 

#### Setting the Time

When adjusting the hour, the “H” will be shown. Press the 'Menu button'  to adjust the hour. Press the 'Confirm' button  to verify the hour, after which you would be able to adjust the and proceed to setting the minute. 

When adjusting the minute, the “M” will be shown. Press the 'Menu button'  to adjust the minute. Press the 'Confirm' button  to verify the time and exit this mode.

### SD Memory Card

In this unit, you can use SD Memory Cards of up to 4GB. To use an SD memory card, turn off the CAM and insert the SD memory card. When the camera is turned on again the SD card icon will be displayed on the LCD screen. The remaining time on the SD card will also be displayed on the LCD screen. All of the video footage will now be saved onto the SD card.

#### Note:

1. If there is an error on the SD memory card, the SD card icon and the letters 'Err' will be displayed on the LCD screen. In this case, turn off the camera and remove the SD card.
2. The SD card is equipped with a Write-Protect switch that can prevent writing and formatting to the card. The letters 'Err' will be displayed if the SD card is locked with Write-Protect switch.

3. We recommend using SanDisk regular or AData SD cards.
4. With use on Windows 2000 users must format to FAT otherwise the SD card and camera may malfunction

#### Available Recording Time

The available recording time is an approximation (these vary depending on the recording conditions and the type of card).

Picture quality setting		VGA 30 fps	QVGA 30 fps
Internal Memory	32 MB	51 s	1 min 36s
SD Memory Card	1 GB	30 min	57 min
	2 GB	60 min	114 min
	4 GB	120 min	216 min

#### IX) Connecting to a computer

You can upload your recorded video footage to a PC by connecting the CAM to your PC using the USB cable.

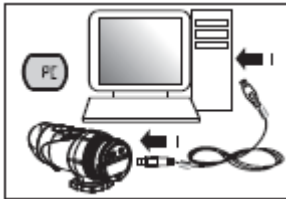

1. Turn the CAM on.
2. Connect the CAM to a PC via the USB cable.
3. There are 2 modes available, File (F) and Cam (C). File allows you to check the files in the camera or SD card. Cam is the webcam function.
4. "F" appears on the CAM LCD screen, which means CAM is connected to your PC and files are available for review.

5. To choose to review Files in the Camera/SD card the user should press 'Confirm' . Once selected the CAM drive appears in the [My Computer] folder.

\*If you are connecting the camera to a PC for the first time, the required driver is installed automatically so that the camera can be recognized by Windows Plug and Play. The 100CAM drive then appears on the [My Computer] folder.

6. Open the '100CAM' folder in the [DCIM] folder to start selecting your desired video files. Copy the desired video to your PC.

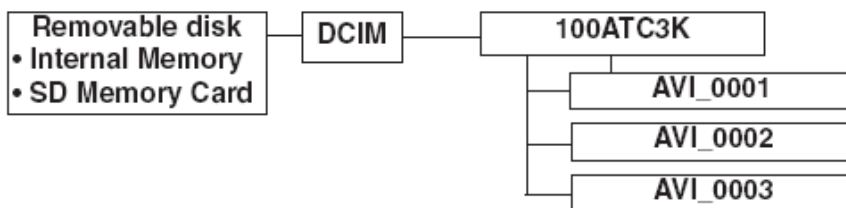

#### X) Webcam installation

**Warning:**

This hardware has not passed Windows Logo testing. Users may install the webcam feature but do so at their own risk. By installing the webcam feature users indemnify

**Attention:**

- \*Webcam Installation does not work with Vista 64 bit versions.
- \* With use on Windows 2000 users must install Netmeeting in order to use the webcam feature.
- \*With use on Windows XP users must install the AMC tool.

**Webcam Installation on Windows Vista**

Note: Before installing the software please ensure the CD is in the CD drive.

1. With the USB cable inserted and camera on, select C on the LCD screen. A pop-up window will appear. Select “Locate and install driver software (recommended)”



1. Click “I don't have the disc. Show me other options”.

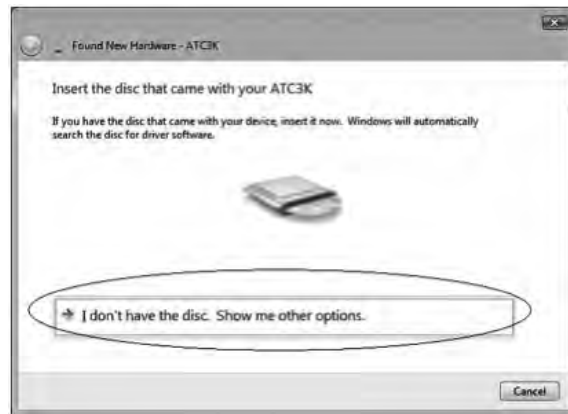

3. Next select “Browse my computer for driver software (advanced)”.

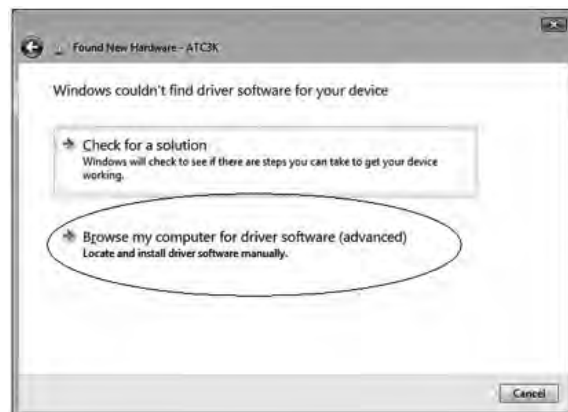

4. After following step 3 you should select browse, CD drive then click next.

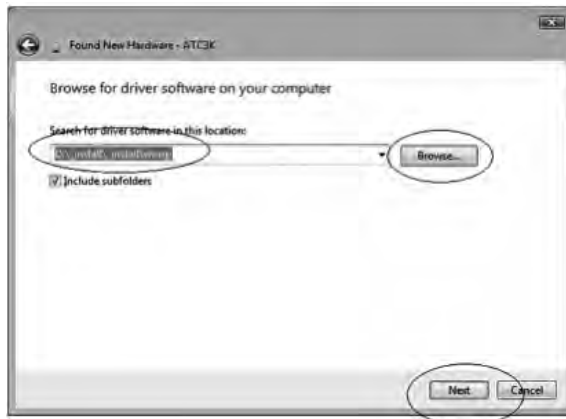

5. When the Windows Security pop up window appears click "Install this software anyway" to continue installing.

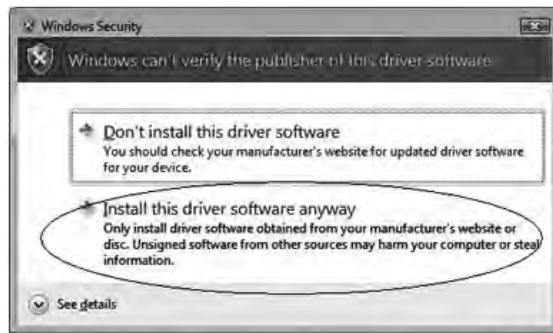

6. Congratulations, you can now use the webcam function on your CAM.



### Webcam Installation Guide on Windows XP

Note: Before installing the software please ensure the CD is in the CD drive.

1. With the USB cable inserted and camera on, select C on the LCD screen. A pop-up window will appear. Select "No, not this time" then click next.



2. Select “Install from a list or specific location (Advanced)” then click next.



3. On the next window select the drop down bar then click on your CD drive letter name before clicking next.

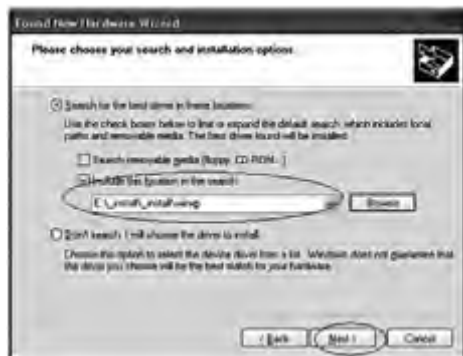

4. The next pop-up window will inform you that our camera has not passed Windows Logo Testing to verify its compatibility with Windows XP. Click “Continue Anyway”.

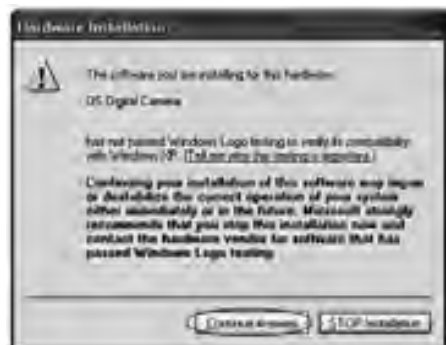

5. A new window will appear, click finish. Your installation of the OS Digital Camera is now complete. Repeat these steps again to install the OS Video Camera and to complete the webcam installation.

6. Once you have installed the webcam, enter “My Computer” and double click on the

OS Video Camera icon, this will open a new window and show the real time view of your CAM. Your camera is now ready to be used as a webcam.

### Webcam Installation on Windows 2000

Note: Before installing the software please ensure the CD is in the CD drive.

1. With the USB cable inserted and camera on, select C on the LCD screen. A pop-up window will appear. Select “next”.



2. Select “Display a list of the known drivers for this device so that I can choose a specific driver”.



3. On the next window select “Other devices” then click next.



4. On the next window click “have disk” then select the CD drive.



5. Select Win2000 from the CD drive then select the icon named "OSUsb" before clicking Open.



6. Ensure the path name is correct then click OK.

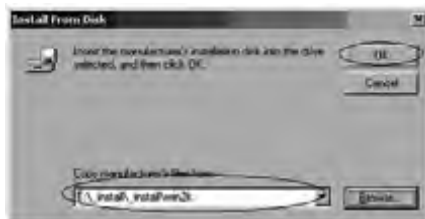

7. Select "OS Digital Camera" then click next.



8. When the next window appears click Next.



9. At this window click the Yes button.



10. Your hardware is now installed. Click finish.



11. Once you click finish the Video Capture Device will begin installing. Repeat the above steps until that has been installed.



12. When in the Win2000 folder in the CD remember to select OSVid, not OSUsb.





13. Click Next after selecting the OS Video Camera.



14. Once you have finished installation your camera will be ready to use as a webcam.

### XI) Webcam USB mode

1. To use the Webcam function, whilst the mode is in F, press 'Menu' . This will change the mode to C. Press 'Confirm'  to select. Once selected the computer will recognize the camera as a webcam.

2. While in either mode, to change to the other, users must disconnect from their PC and reconnect going through the entire selection procedure again.

3. The camera will use power from the computer.

#### Note:

1. Videos will be saved in AVI format.

2. When the CAM is connected to the PC with an SD card inserted in the camera, the '100CAM' folder will show the files on the SD card.

3. Webcam mode is not available with Apple Mac. You can upload your recorded video footage to a MAC by connecting the CAM to your MAC using the USB cable.

1. Turn the CAM on.

2. Connect the CAM to a MAC via the USB cable.

3. There are 2 modes available, File (F) and Cam (C). File allows you to check the files in the camera or SD card. Cam is

the webcam function.

4. "F" appears on the CAM LCD screen, which means CAM is connected to your MAC and files are available for review.

5. To choose to review Files in the Camera/SD card the user should press 'Confirm' . Once selected the CAM drive appears in the [My Computer] folder.

\*If you are connecting the camera to a MAC for the first time, the required driver is installed automatically

6. Open the '100CAM' folder in the [DCIM] folder to start selecting your desired video files. Copy the desired video to your MAC.

7. While in either mode, to change to the other, users must disconnect from their MAC and reconnect going through the entire selection procedure again.









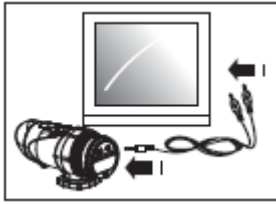

8. The camera will use power from the computer.

#### Note:

The webcam comes with a webcam stand. Please use this when using your CAM as a webcam.

### XII) Playing back video footage on a TV



1. Turn the CAM and TV off.
2. Connect your CAM to your TV using the AV cable.
3. Turn the TV and CAM on.
4. There are 2 modes available, Playback (PB) and Viewfinder (VF).
5. "PB" appears on the LCD screen as default. To change to VF press the 'Menu' button then 'Confirm' . Once this mode is selected, a real time image will appear on your TV screen (or PMP). When in VF mode all record functions are disabled. TV mode is automatically activated when the AV cable is connected to the CAM and TV.
6. If PB mode is selected the function keys will be shown on the TV screen. The function keys include Pause , Stop , Scan Back , Play , Scan Forward  and Delete One .
7. Press the Menu button  to move the highlight cursor along the function keys.
8. Press the Confirm button  when the desired function key is highlighted.
9. To delete one file, select the Delete-One icon and confirm by pressing the Confirm button .
10. Whilst in either mode, to change to the other, the AV cable must be disconnected and step 1 through to step 4 should be followed.

### **XIII) Troubleshooting**

#### **There's no display**

- Are the batteries properly installed?
- Do the batteries need replacing?

#### **After the CAM is connected to my PC, it cannot find the new drive in the, 'My Computer' folder**

- Ensure each end of the CAM USB cable is properly and firmly connected.
- Ensure your USB port is working properly. Try connecting another USB device into the port. If the other device does not work, the USB port may have a malfunction. In this case, contact your system manufacturer or the manufacturer of your USB card.

#### **I can't capture video footage**

- Ensure there is enough space on the internal memory of CAM or the SD card; the display will tell you how much time there is left for video recording.
- Ensure the SD card is not locked. The letters "Err" will be displayed if the SD card is locked.

#### **The remaining time is not accurate**

- The remaining time is an estimate.
- The remaining time depends not only on the time recorded, but on the color density of the video footage. Under conditions with high contrast, such as outdoors, the actual time available will be less than under low-contrast conditions, such as indoors.

**I can't play the video footage on my television**

- Ensure each end of the AV cable is properly and firmly connected to CAM and to your television.
- Ensure the CAM and television are both turned on. -Ensure you have selected PB to view files.

**Some captured video footage cannot be found when SD card is inserted**

- The video footage may be stored on the internal memory. Connect the CAM to your PC without an SD card, and it will show the files in the internal memory.

**The sound is very low or there is no sound**

- Ensure the audio is on by following the instructions in the Sound Recording section.
- The CAM is specifically designed for extreme sports and is waterproof, it is for this reason that we have made the microphone less sensitive.